

Made in Switzerland
瑞士製造



SLIDING DOORS



- High-quality trolleys enable easy sliding even with just one hand and with no sound
高品質滾輪令移門開關順暢、安靜無聲，單手操作便可
- Robust, maintenance-free design with fiberglass-reinforced toothed belt
玻璃纖維加固的齒輪狀運輸帶令設計堅固耐用
- Doors and toothed belt fastener are easily installed and removed from one side
門及齒輪狀運輸帶很容易從一邊安裝及卸除下來
- Allow large openings without bottom guide channels
提供寬闊的開門空間之餘地上又不會留下地槽痕跡

HAW-ARCH03

HAWA-Symmetric 80/Z hardware system for simultaneous opening and closing of 2 wooden sliding doors to the left and right

HAWA-Symmetric 80/Z 2扇移門同步反向移開至左側及右側並同步關閉五金連鋁質頂吊路軌

Track length 路軌長度	: 2000 mm x 2 pcs
Max. door weight 門承重	: 80 kg (每扇門計)
Door width 門寬度	: 500-1200 mm
Height adjustable 垂直調較	: +/-3 mm

Each set comprising 每套包括配件:

2 pcs	Guide pulley wheel matching with top track HAWA-Junior 80 與頂路軌協調的定向滑輪	
1 pc	Toothed belt lock for manual system 手動系統下的齒狀運輸帶止動器	
1 pc	Driver laterally adjustable for manual system 手動系統下可側面調較的的驅動器	
1 pc	Toothed belt, black, unit 10 m 黑色齒狀運輸帶，10米長	
4 pcs	Two-wheeled trolley, M10 with plastic wheels 由兩個塑料輪子組成的滾輪	
4 sets	Two-way suspension plate, with hanger bolt M10 and fixing screws 雙向安裝滾輪固定吊片連吊掛螺栓及螺絲	
1 pc	Track stop, adjustable retaining force 路軌尾掣	
2 pcs	Screw-on rubber door stop 門掣	
2 pcs	Guide, for screw mounting to floor, black plastic 黑色塑料導向地掣	
1 pc	Vertical adjustment pin 垂直調較針	
2 pcs	Top track, alu plain anodized, predrilled, 2 m 2米長鋁質頂路軌	

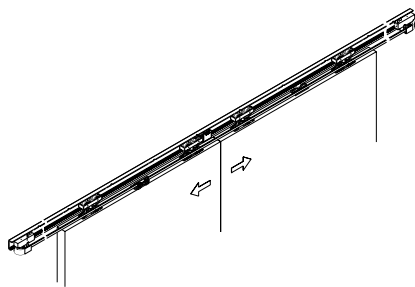
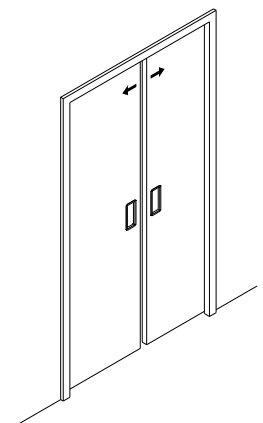
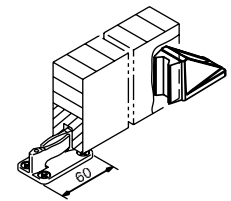
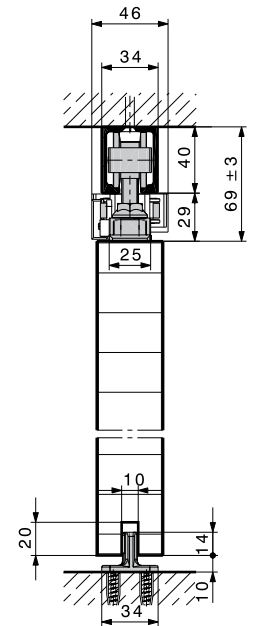

Remarks: The length of the toothed belt has been calculated for 2 sliding doors with a maximum width of 1200 mm.
備註：齒輪狀運輸帶之長度適用於2扇移門，每扇門寬度不超過1200 mm。

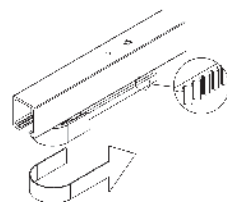
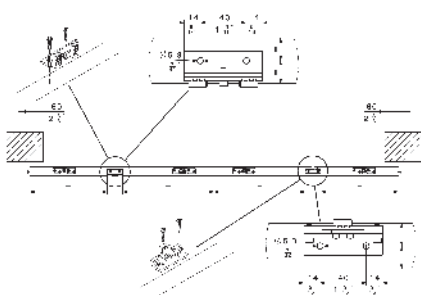

Toothed belt teeth on outer side
運輸帶齒輪向外

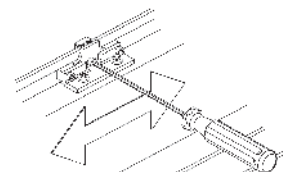
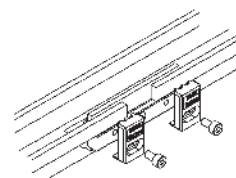

Made in Switzerland
瑞士製造



SLIDING DOORS

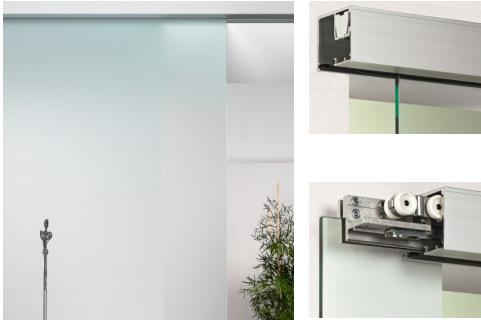

HKS-3010

EKU-PORTA 100 GW sliding system for one top-running all-glass door with running gear concealed in the ceiling mounted, aluminium anodized running track
EKU-PORTA 100 GW 隱藏式懸掛單扇玻璃窗移門五金連鋁質頂吊路軌

- Track length 路軌長度 : 2500 mm
- Max. door weight 門承重 : 100 kg per door (每扇門計)
- Max. door width 門最大寬度 : 1200 mm
- Max. door height 門最大高度 : 2700 mm
- Glass thickness 玻璃厚度 : 8-12.7 mm

Mounting Example 安裝範例:

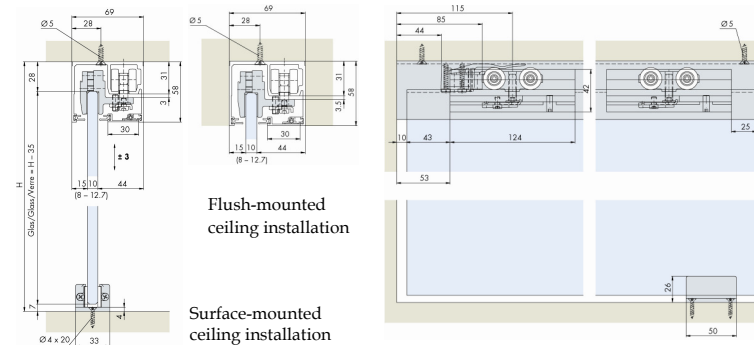
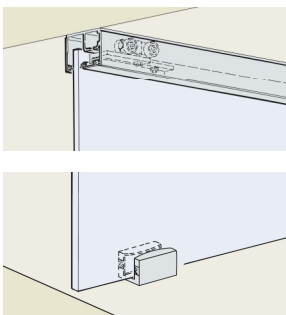

Accessories included:
每套包含以下配件:

2x	2x	2x	1x
1x	1x	1x	12x
1x	1x	2.5 m	
1x	2.5 m	5 m	

The glass is held at the top by two glass clamp shoes that are connected to the running gear. The running equipment is fully integrated in the running track.
兩個連接到滾輪裝置的玻璃夾把玻璃固定在頂部。懸掛配件及滾輪隱藏於軌道中，門表面整體均為玻璃，外觀整潔。

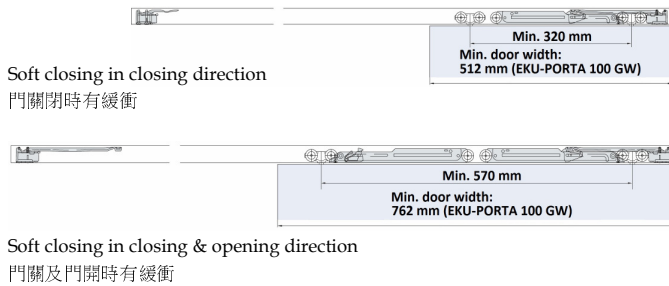

HKS-3013/S

Set of soft and self closing mechanism on one side or both sides, for EKU-PORTA 100 Glass system
自閉及緩閉阻尼器套裝，可單邊或雙邊使用，EKU-PORTA 100 玻璃移門系統適用

Accessories included in a set:
每套包含以下配件:

1x	1x	
----	----	--

Mounting Example 安裝範例:

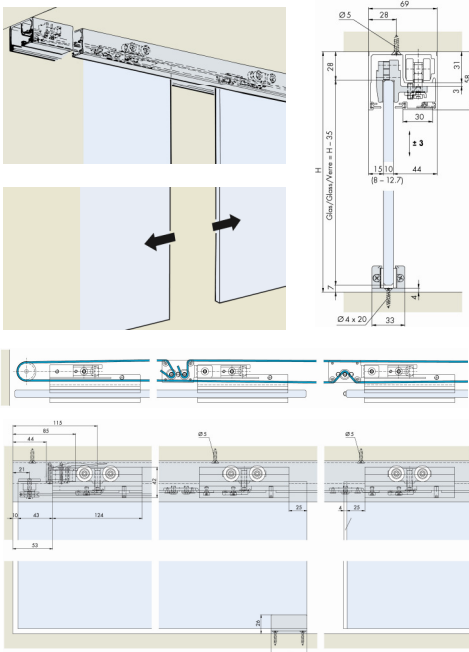

HKS-3011

EKU-PORTA 100 GW Synchro sliding system for synchronized opening and closing of 2 all-glass doors with ceiling mounted, aluminium anodized running tracks, and a Kevlar rope
EKU-PORTA 100 GW Synchro 雙扇左右單軌同步連動型玻璃移門五金套裝，配鋁質頂路軌及連動索

- Track length 路軌長度 : 2500 mm x 2 = 5000 mm
- Kevlar rope length 連動索長度 : 10 m
- Max. door weight 門承重 : 100 kg per door (每扇門計)
- Max. door width 門最大寬度 : 1200 mm
- Max. door height 門最大高度 : 2700 mm
- Glass thickness 玻璃厚度 : 8-12.7 mm

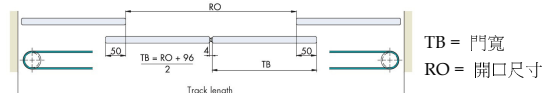

A Kevlar cord connects 2 all-glass doors (100 kg) for synchronous opening and closing
配有連動索，開啟/關閉一側的玻璃門後，另一側的玻璃門也會連動開啟/關閉

Accessories incl. in the extra fitting set:
每套連動型雙門規格額外包含以下配件:

1x	1x	10 m
2x	2.7 m	2x

Made in Switzerland
瑞士製造



SLIDING DOORS

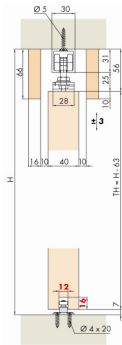

HKS-3001

EKU-PORTA 100 H sliding system for single wooden door with ceiling mounted, aluminium anodized running track with assembly opening
EKU-PORTA 100 H 單扇木質移門五金連鋁質頂吊路軌(帶簡易移除及安裝門板功能)

- Track length 路軌長度 : 2500 mm
- Max. door weight 門承重 : 100 kg per door (每扇門計)
- Max. door width 門最大寬度 : 1200 mm
- Max. door height 門最大高度 : 2700 mm
- Door thickness 門厚度 : 30-50 mm

Mounting Example 安裝範例:

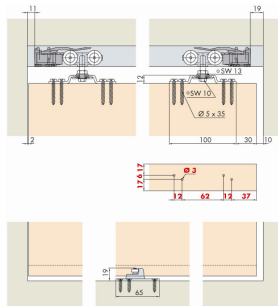
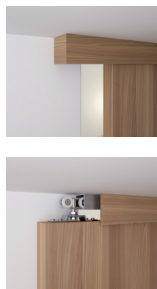
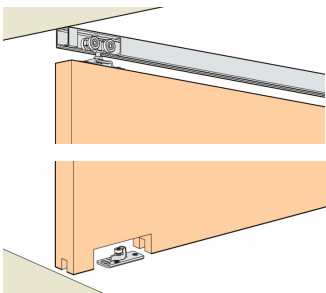

HKS-3005/S

Set of soft and self closing mechanism on one side or both sides, for EKU-PORTA 100 Wood system
自閉及緩閉阻尼器套裝，可單邊或雙邊使用，EKU-PORTA 100 木質移門系統適用

Soft closing in closing direction

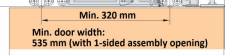

門關閉時有緩衝

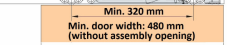

Soft closing in closing & opening direction

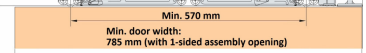

門關及門開時有緩衝

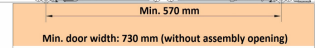

Optimum running characteristics thanks to ball bearing-mounted running gear and bottom guide with roller

採用滾輪軸承的驅動裝置及帶滾筒的底部導向座，移動非常順暢

Accessories included in a set:

每套包含以下配件:

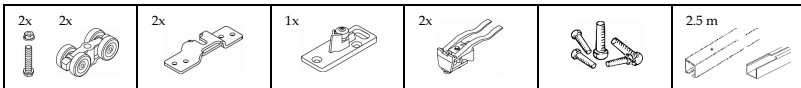

Accessories included in a set:

每套包含以下配件:

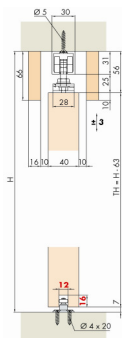
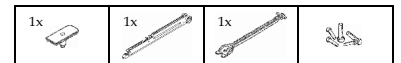

HKS-3003

EKU-PORTA 100 H Synchro sliding system for synchronized opening and closing of 2 wooden doors with ceiling mounted, aluminium anodized running tracks with assembly opening, and a Kevlar rope

EKU-PORTA 100 H Synchro 雙扇左右單軌同步運動型木質移門五金套裝，配鋁質頂路軌(帶簡易移除及安裝門板功能)和連動索

- Track length 路軌長度 : 2500 mm x 2 = 5000 mm
- Kevlar rope length 連動索長度 : 10 m
- Max. door weight 門承重 : 100 kg per door (每扇門計)
- Max. door width 門最大寬度 : 1200 mm
- Max. door height 門最大高度 : 2700 mm
- Door thickness 門厚度 : 30-50 mm

Mounting Example 安裝範例:

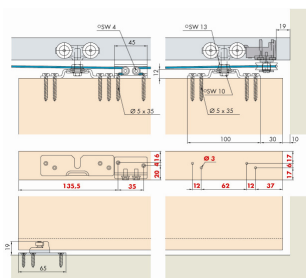
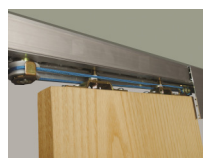
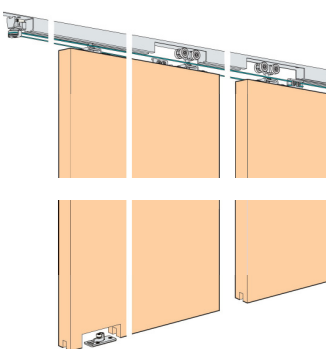

Accessories incl. in the extra fitting set:

每套連動型雙門規格額外包含以下配件:

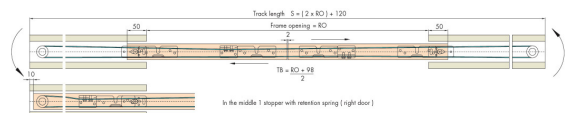
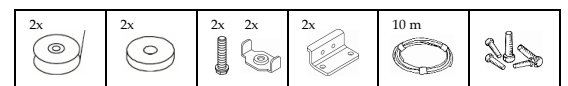

A Kevlar cord connects 2 wooden doors (100 kg) for synchronous opening and closing
配有連動索，開啟/關閉一側的門後，另一側的門也會連動開啟/關閉

S = 軌道長度

TB = 門寬

RO = 開口尺寸